

General Instructions

BAIO® System

For decades mainly flangeless components have been used for pipes and pipe fittings of buried supply lines, as this coupling system affords some technical and economic advantages compared with flanged connections and welded connections. These generally acknowledged benefits can be applied without any qualification to connections between pipelines and valves as well as between fittings themselves.

Therefore, the flangeless coupling system Hawle BAIO® has been developed. By means of a universal bayonet push-fit socket valves and pipe fittings can be connected restraint without major effort.

Apart from the technical advantages (e.g. possibility of bends, integral corrosion protection, simple in-stallation) the efficiency of the push-fit technology (potential cost savings due to shorter installation times and a lower number of components for each connection) is of special importance. Valves and pipe fittings are coupled via a bayonet connection.

The below pictures illustrate how the use of a push-fit coupling cuts down the number of components involved, thus considerably reducing installation time.

The installation times established in practice show that the assembly of a push-fit coupling will require only about one third of the time needed for a flanged connection.

The BAIO® system in comparison to flanged fittings

Flange-System: 307 components

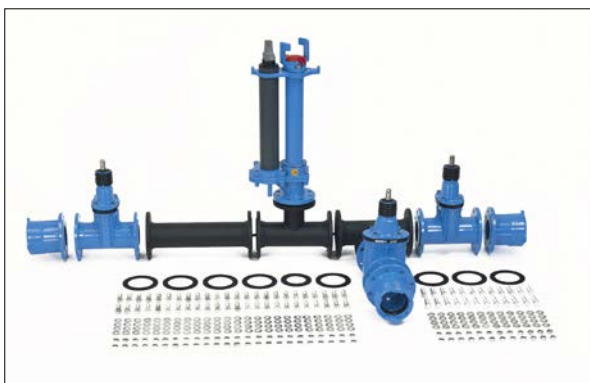

BAIO®-System: 7 components

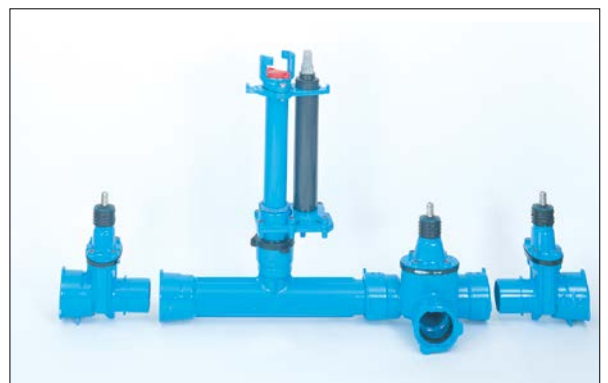

General Instructions BAIO® System

ONE push-fit connection - FOUR types of pipe: Cast iron, PVC, PE and steel pipe*

* (use steel fusion tail 452S1)

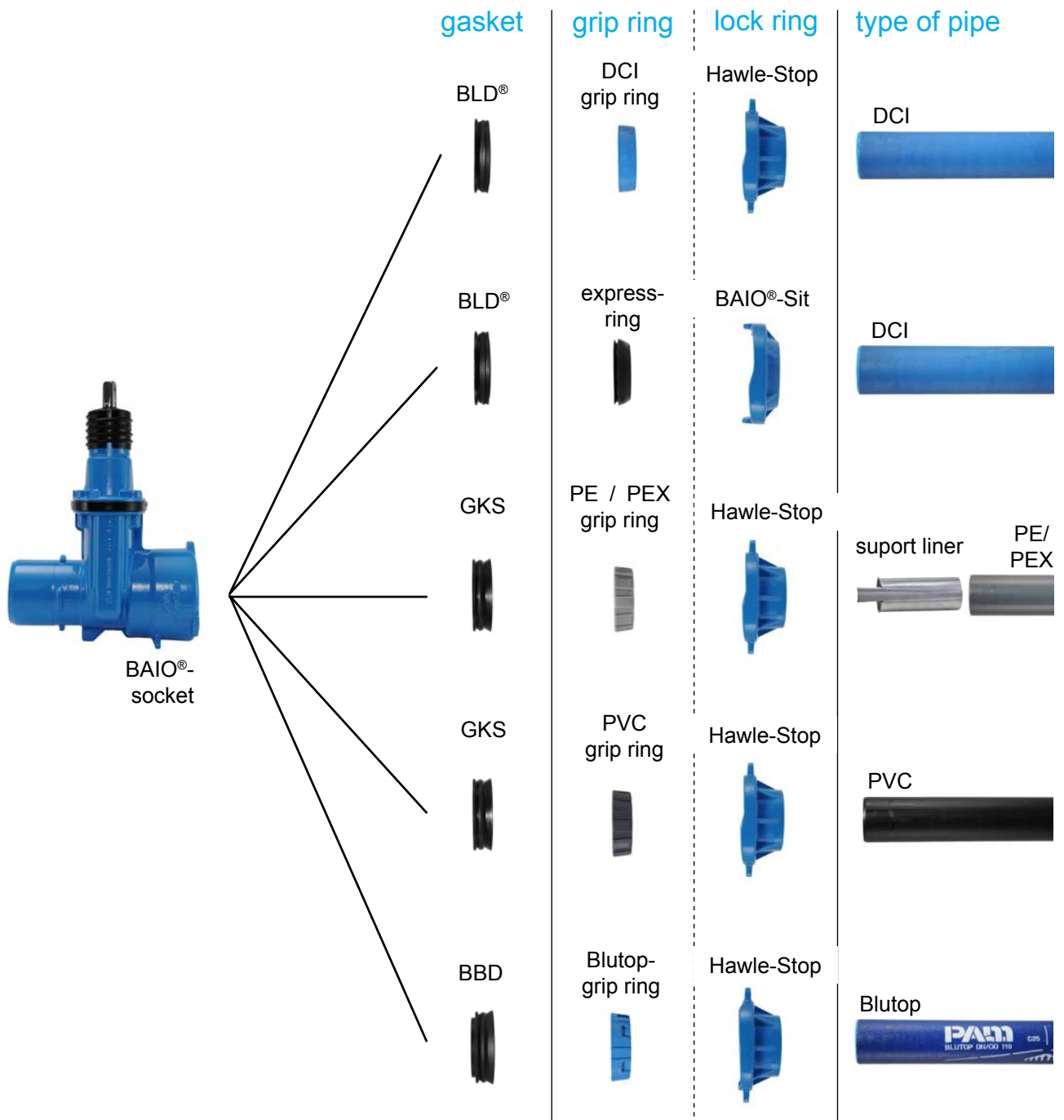

General Instructions BAIO® System

Extracts from DVGW Water Information No. 49, Edition 4/97

Flange-less pipe connections for fittings in water transport and distribution systems

„The classical advantage of flanged connections with regard to easy disconnection when replacing defective fittings has therefore lost its status. The use of flange-less fittings in Underground pipeline construction should therefore always be the norm“.

„Nowadays the majority of connections in underground pipelines are of the push-fit type, since the technical and financial benefits are considerable compared to flanged connections. These generally recognised advantages

Can be transferred to the connection between fittings and pipelines without restrictions.“

„The fittings that have been tested and registered with the DIN/DVGW test symbol are available on the market in many flange-less design variants, and should only be used in these design variants in future.“



Technical description

BAIO®-System

The idea of the Hawle-BAIO®-System is based on a spigot end/socket connection, with dimensions taken over from the DCI pipe. This makes it possible to use the system for DCI pipes with BAIO® lip gasket (BLD®), and it can also be used for PVC and PE pipes providing that a cast plastic gasket is used.

For PE and steel pipes there are also components with fusion tails for welding to the relevant pipe ends.

The axial restraint between the BAIO® components is made in a positive locking way via the bayonet coupling, which is used in many technical areas.



Technical characteristics:

- Quick and easy installation
- Small number of components and connections
- Push-fit socket connection that can be directed to all sides
- Tension-free installation
- Low storage cost
- Universal use with DCI, steel*, PE, PVC and AC** pipes
- Earthing-free pull lock with Hawle-Stop
- Integral heavy-duty corrosion protection with Hawle epoxy powder coating

* with 452ST steel weld-in end

** with EMS with multi/joint sleeve 5307

Technical data:

Medium:	Potable water, sewage water, natural gas* (please specify the medium and the type of pipe so that the correct gasket is supplied. Standard: BAIO® lip gasket for water)
Max. operating pressure	16 bar
Nominal widths:	DN 80 to DN 300 (in combination with ZAK-System: d25 to DN 300)
Certification:	in accordance with DIN EN 545, DIN EN 969 and VP 545
CE symbol (shaped part):	in accordance with DIN EN 598 and DIN EN 969

* BAIO®-System for Gas





Since special gaskets are required for use in the gas area, please specify „For use in gas area“ when ordering! The gaskets are pre-installed in the factory. Gas gasket must be marked as such. Unmarked gaskets must not be used in the gas area.

Technical description

BAIO®-System

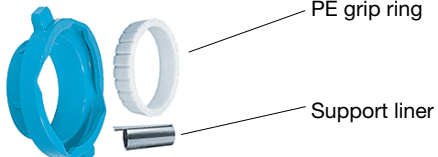
Installation of fittings in the BAIO®-System in combination with different types of pipe

For tight pipe connections in BAIO® sockets with axial restraint, different gaskets and lock rings must be used depending on the type of pipe.

Pipe material	Gasketdata:	Axial restraint (pull lock)
<p>DCI pipe (GGG) in accordance with DIN EN 545</p> <p>Steel pipes with cast iron pipe outer diameter</p>	<p><u>Potable water / sewage water</u> BAIO® lip gasket</p> <p><u>Gas</u> DCI pipe gasket, gas resistant</p>	<p>DCI grip ring</p>  <p>Hawle-Stop [DCI]</p>
<p>PE pipe: PE 80, PE 100 in accordance with DIN 8074/75 SDR 11 / 17 / 17.6</p> <p>PE-X pipes in accordance with DIN 16892/93 SDR 11 / 17 / 17.6</p> <p>We recommend roughening the ends of pipes with an extremely smooth surface (e.g. PE-X pipes) in the clamping area!</p>	<p><u>Potable water/sewage water:</u> plastic gasket ring</p>	 <p>PE grip ring</p> <p>Support liner</p> <p>Hawle-Stop (PE) use support liner (oder separately)!</p>
<p>PVC pipes in accordance with DIN 8061/8062</p>	<p><u>Potable water/sewage water:</u> plastic gasket ring</p> <p><u>Gas:</u> plastic gasket ring, gas resistant</p>	 <p>PVC Corundum grip ring</p> <p>Hawle-Stop [PVC]</p>
<p>PE pipe: PE 80, PE 100 in accordance with DIN 8074/75 SDR 11 / 17 / 17.6</p> <p>PE-X pipes in accordance with DIN 16892/93 SDR 11 / 17 / 17.6</p>	<p><u>Potable water/sewage water:</u> BAIO® lip gasket</p> <p><u>Gas</u> Cast iron pipe seal, gas resistant</p>	 <p>PE-fusion tail with integrated support liner and lock ring</p>
<p>Steel pipe in accordance with EN 10224 / DIN 2460</p>	<p><u>Gas</u> DN 80, DN 100, DN 150 and DN 200: Cast iron pipe gasket, gas resistant DN 125: plastic gasket ring, gas resistant</p>	 <p>Steel pipe fusion tail with integrated lock ring</p>

Technical description BAIO®-System

Dirt seal for socket

When plastic pipes are being connected in BAIO® sockets and the soil has a high lime or sand content, we recommend the use of the socket dirt seal, since soiling that is washed in or pushed in during installation can have a detrimental effect on the sealing. The socket dirt seal must be inserted into the ring gap in front of the Cast plastic sealing ring before installing the pipe.

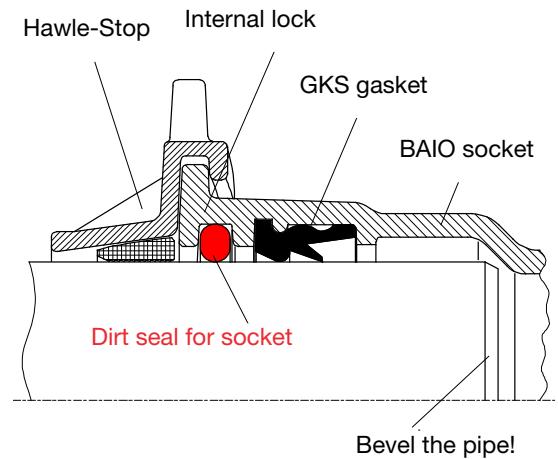

Installation of PE pipes DN 125/ d125, DN 200/d 200 and DN 250/d 250 in BAIO® sockets

With the following nominal widths, both the GKS gasket and a support ring must be inserted into the BAIO® socket to prevent excessive pipe bending.

BAIO®-socket DN	External pipe ø (d) mm	Position of support ring in BAIO® socket	
125	125	rear	
200	200	rear	
250	250	front und rear	

Technical description

BAIO®-System

Installation of PE pipes DN 100/d 125, DN 150/d 180 in BAIO® sockets

Connecting d 125 PE pipes in BAIO® DN 100 sockets or d 180 PE pipes in BAIO® DN 150 sockets is only possible in combination with special SM pieces (order no. 532). The GKS gasket ring is already installed in these SM pieces in the factory.

HSM gate valve DN 150 / d 80 (4511501801) can also be used for pipe outer diameter d 180. The spigot end of this gate valve fits into the specially developed MMB pieces (5421501800, 5421801 500, 5421801800).

Dirt cover and locking ring

Hydrants, air valve sets and shaped parts (e.g. vertically installed SM piece) with BAIO® spigot end be safeguarded against unintentional unlocking using the anti-dirt and anti-twist protection.



Unlocking protection for BAIO® spigot end/socket connection.

The unlocking protection prevents unintentional unlocking of BAIO® spigot end/socket connections, e.g. during comprehensive pre-assembly outside the trench.

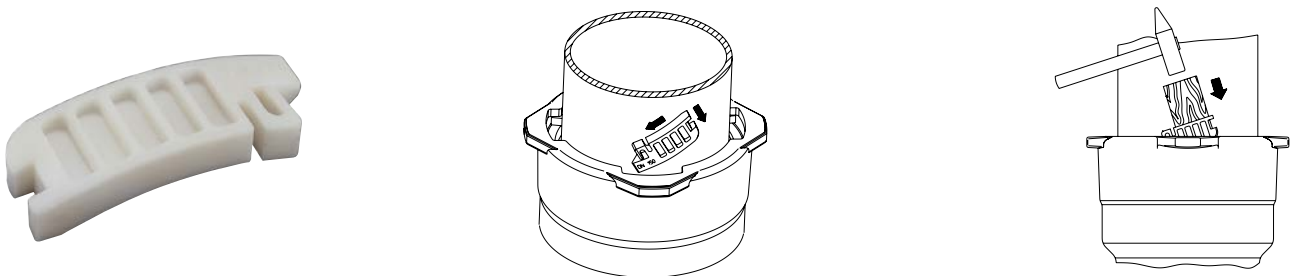

Transition to nominal widths of smaller than DN 80.

For a restraint transition to nominal widths of less than DN 80, the adapter with BAIO® spigot end DN 80 and ZAK® socket ZAK 46 must be used. In the ZAK®-System, fittings, shaped pieces and fittings are locked using a bayonet connection, as with the BAIO®-System. Detailed information about the ZAK®-System can be found in chapter 2.

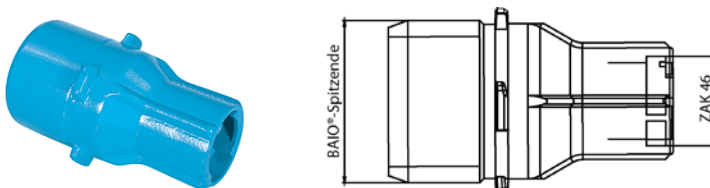

Illustration: Adapter, BAIO® spigot end DN 80 to ZAK® socket (ZAK 46)

Technical description BAIO®-System

EMS pieces for rehabilitation (e.g. incorporating a new pipe junction in an existing line)

The Hawle BAIO®-System is also used for rehabilitate existing pipeline networks. The installation socket piece (EMS) with threaded socket or WAGA Multi/Joint® multipurpose coupling must be used for this purpose.



Installation example

DN	EMS with threaded socket		EMS with Multi/Joint®		HSM
	L _{min}	L _{max}	L _{min}	L _{max}	
80	220	380	230	527	210
100	235	390	244	494	215
125	260	415	240	477	240
150	260	415	285	517	250
200	275	480	250	580	275
250	260	460	-	-	373
300	260	460	-	-	422

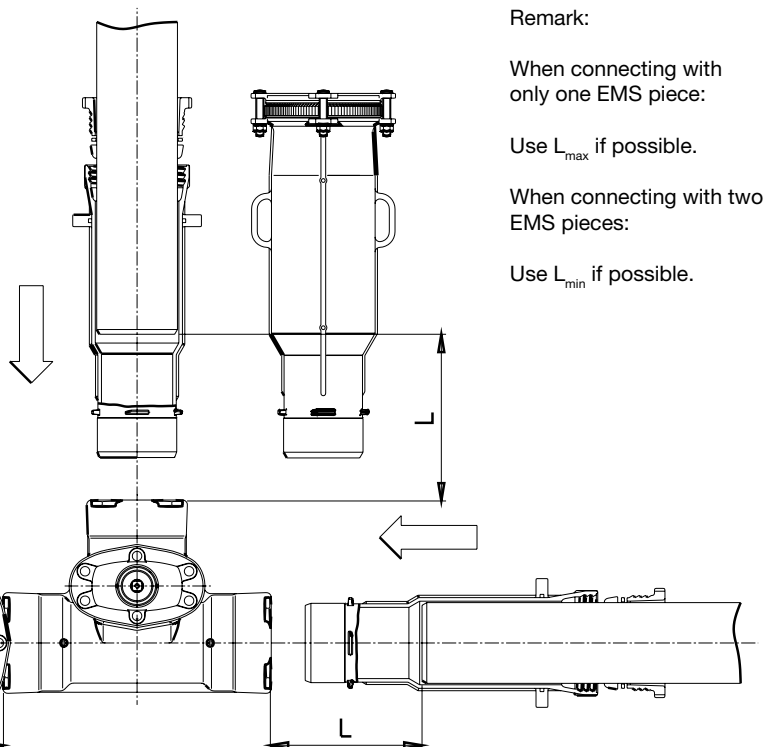

Technical description BAIO®-System

EMS with Multi/Joint®

Restraint connections are made when connecting DCI, steel, PE and PVC pipes using suitable Uni/Fikser® clamping segments (see table for use per pipe type) on the Flekskern® of the Multi/Joint® socket.



Uni/Fikser®

Notice: Glass-fibre and AC pipes must be installed without „Fikser“ (not restraint). Before installation remove grip segments (Fikser) from grip ring of Multi/Joint coupling.

When connecting PE pipes, a support sleeve (ORIGINAL WAGA/GF SUPPORT SLEEVE ONLY) must be used. The support sleeve must be located in the clamping area of the Multi/Joint® socket after installation. Uni/Fikser® must be used in the Flekskern® of the Multi/Joint® socket.

Compaction in crossing area

Because of the compact design of the Hawle BAIO®-System, special attention must be paid to compaction in crossing areas.

Surface boxes in the BAIO®-System

For BAIO® crossings with two or three gate valves special support plates (see illustration) that are designed for a nominal width range of DN 80 - DN 200 must be used.

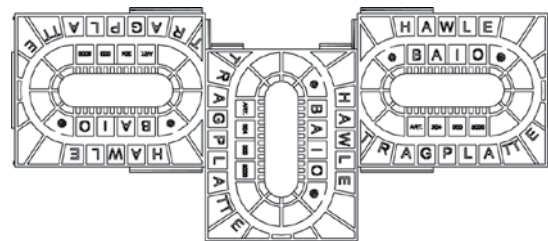
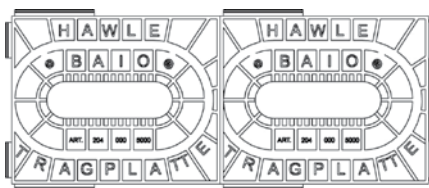

Hawle-BAIO®-CAD

Hawle BAIO® CAD is the ideal program for construction, depiction and documentation of BAIO® nodes. The latest version can be found on our Web site at www.hawle.de.

Illustration:

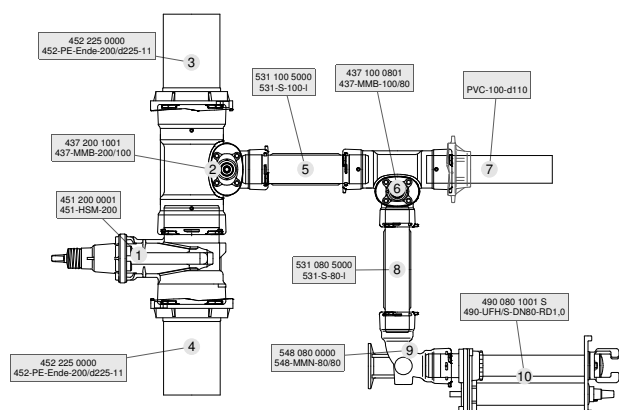

General information

ZAK[®] system

Threadless connection system

Threaded connections no longer correspond to today's state of the art, because they are prone to corrosion. Despite careful sealing during installation there will always be some unsealed thread pitches permanently exposed to the medium. Within the metal blank transition area, contact corrosion occurs - cross-section limitations due to encrustations are the result. The consequence: the house connection needs renewal.

The ZAK[®] system is a bayonet connection consisting of a corrosion-protected socket with inner bayonet lock and a likewise corrosion-protected spigot end with interlocking lugs and double O-ring gaskets.

During installation, only the ZAK[®] spigot end is pushed into the ZAK[®] socket, locked by a clockwise rotation by 90°, and pulled back as far as it will go. In order to arrest the ZAK[®] spigot end in the ZAK[®] socket, the connection must be secured against accidental disengagement via an anti-turn locking device.

After the flangeless BAIO[®] system, the threadless ZAK[®] system now supersedes usual joining techniques. The crucial item for this simplified and optimised type of joining is the need of the utility companies to reduce costs during the subsequent period by means of a longer service life regarding components protected against corrosion from all sides.



The connection options with the Hawle BAIO[®] system (see chapter 1) result in an continuous from d 25 to DN 300.

Technical description

ZAK[®]-System

Nominal widths:

- ZAK 34 - corresponds to dimension 1"
- ZAK 46 - corresponds to dimension 1 1/2"
- ZAK 69 - corresponds to dimension 2"

Technical features:

- simple and quick installation
- joining technique without any threads
- reduction of tension due to the flexibility of the joint
- secure double O-ring seal for the joint
- long service life due to integral corrosion protection
- no tools required for installation

Technical data:

Housing:	GJS-400
Corrosion protection:	Hawle epoxy powder coating
Anti-turn locking device:	POM
Max operating pressure:	Drinking water, sewage water: 16bar Gas: upon request

The connection option with the Hawle BAIO[®] system provides the user with an end-to-end corrosion-resistant system from d 25 to DN 300. Further information on the BAIO[®]-System can be found in chapter 1.



BAIO[®] all socket tee + Transition fitting BAIO[®] DN 80 - ZAK 46 + service valve